



ITT Controls

Gas Regulation Overview

Regulator Product Line

Actaris Gas is a major business line of the Actaris Group, an established global leader in metering products and systems for distributing gas, electricity, water and heat.

Actaris has over 100 years of proven experience in the manufacture and use of Gas Pressure Regulators and associated safety devices. Our Total Quality policy ensures that today's technically advanced product ranges comply with the highest national and international standards, to meet the exact needs of different gas distribution systems in North America and Europe.

Our Gas Pressure Regulators are designed for accurate, dependable and safe use with most non-corrosive gases including air, nitrogen, dry carbon dioxide, and propane, in natural gas distribution systems and industrial applications such as burners and boilers.

An extensive range of regulators is manufactured to US standards in Owenton, Kentucky. This line is designed with a building block approach, utilising common components and parts throughout the product range. The result is an extremely versatile and innovative product range that offers an economical solution to the most challenging regulator applications.

The European product line, manufactured in Karlsruhe, Germany covers most applications in natural gas distribution, from high pressure regulators used in city gate stations to residential regulators. These regulators and safety devices offer a wide range of combinations, including integral safety shut-off valves and built-in creep relief valves.



▶ A Unique Safety Feature: the Internal Monitor

A unique safety feature available exclusively in Actaris regulators is the **Internal Monitor (IM)**. A secondary orifice and valve seat enable an IM regulator to control the flow of gas and to lockup in the event of a failure at the main seat and orifice. The IM

prevents the venting of large amounts of gas into the atmosphere and does not require manual resetting. For added safety and overpressure protection, the IM is a cost-effective alternative to installing monitor regulators or external relief valves.

Normal Operation

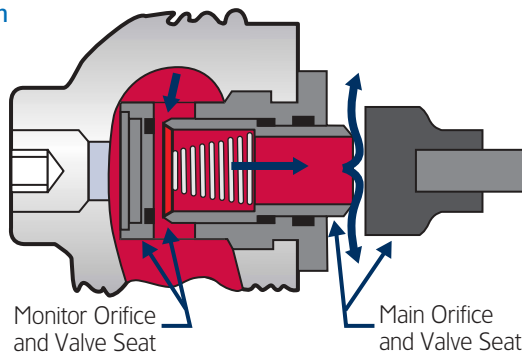

The internal monitor (IM) operates like a standard upstream monitor set, in that the monitor orifice is wide open under normal conditions. Normal regulation and lockup occur at the main valve seat and orifice. (The closing spring causes CL models to lock up at both seats under normal conditions.)

Internal Monitor Operation

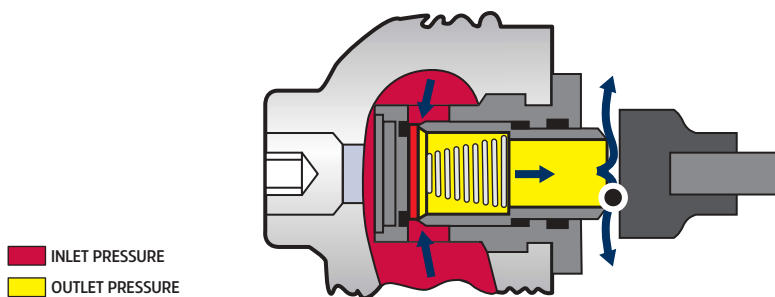

If the regulator fails to control the flow of gas due to foreign matter or damage at the main seat and orifice, the secondary orifice automatically takes control at a slightly elevated outlet pressure. The point of regulation moves to the upstream monitor seat and orifice.

Index

- ▶ Low Pressure Regulators 4
- ▶ Spring Loaded Service Regulators 5
- ▶ Constant Loaded Regulators 7
- ▶ Twin Parallel Flow Regulators 9
- ▶ Field Service Regulators 10
- ▶ Regulators with built-in Slam-shut Valves 11
- ▶ Pilot Operated Regulators 12
- ▶ Spring Loaded Regulators for the German Market 14
- ▶ Creep Relief Valves 15

▶ Low Pressure Regulators

Actaris low pressure regulators are designed for residential customers or small collective distributors wherever the network pressure is slightly higher than the typical 19 to 22 mbar, including urban centre networks and old renovated networks. They function perfectly with very little pressure loss and are designed to be mounted directly onto users' meters or at the foot of their residential buildings.

These regulators meet all security requirements for use inside residential buildings. When necessary, they are equipped with a security device to protect against excess flow – usually with automatic reset. This interrupts the gas flow if there is abnormally high demand, in the case of rupture of a conduit downstream to the regulator, for example, or an abnormal drop in inlet pressure in the distribution network.

▶ WMR



Designed for residential applications from low pressure service lines. WMR can be mounted directly to meter inlet pipe. Its compact angle design makes it specially adequate for installation in space saving meter boxes, indoors or outdoors, or in meter bars.

Outlet Pressure:	up to 35 mbar	up to 13" WC
Max. Inlet Operating Pressure:	500 mbar	7 psig
Connection Sizes:	meter couplings 3/4" and 1"	
Options:	Gas loss protection, meter bar mounting	

▶ SERus



Light, compact and fire-resistant regulator for mounting on 2-pipe meters (RF1 G4, RF1 G6, G10, G16) or mono-pipe meters (RF1 G4, RF1 G6).

Outlet Pressure:	up to 33 mbar	up to 14" WC
Max. Inlet Operating Pressure:	200 mbar	1.5 psig
Connection Sizes:	meter couplings 3/4", "1, 1-1/4" and 1-1/2", mono-pipe meter coupling 1"	
Options:	Gas loss protection	

▶ HR 91 Series



Range of fire-resistant regulators fitted with safety diaphragm, for multiple residential users.

Outlet Pressure:	up to 50 mbar	up to 20" WC
Max. Inlet Operating Pressure:	100 mbar	1.5 psig
Connection Sizes:	screwed 1", 1-1/4", 1-1/2" and 2", mono-pipe meter coupling 1"	
Options:	Gas loss protection	

▶ Spring Loaded Service Regulators

Actaris Spring Loaded Service Regulators are used primarily for final stage lower outlet pressure applications (20 mbar to 150 or 350 mbar – Inches W.C. to 2 or 5 psig). Typical applications include residential and low outlet pressure commercial and industrial gas supply, and all types of gas-fired equipment including furnaces, boilers, dryers, ovens, heaters etc. Spring loaded regulators provide extremely fast response to changing downstream flow conditions. Unique features of Actaris spring loaded service regulators include:

▶ Controlled Boost

All regulators are equipped with boosting devices (B42: raised lip on valve seat, all others: adjustable loading ring) to offset pressure droop at

high flows caused by spring and diaphragm effect.

▶ Controlled Breather Opening

All regulators are equipped with a soft seat vent valve to ensure proper breathing and stability under all conditions.

▶ High Capacity Internal Relief

All spring loaded regulators are equipped with internal relief as standard, relief flow paths are as large as practical to provide the least resistance to venting gas in the event of an over pressure situation, thus minimizing pressure build-up.

▶ B42 Series



▶ B31 Series



▶ B34S Series



▶ B34 Series



▶ B38 Series



Light, compact service regulator that provides the power, capacity and relief performance of much larger regulators.

Outlet Pressure:	LP to 340 mbar	" WC to 5 psig
Max. Inlet Operating Pressure:	8.6 bar	125 psig
Connection Size(s):	Threaded 1/2", 3/4", 1" and 1-1/4"	
Options:	Relief valve	

High-performance service regulator with a large effective diaphragm area and powerful lever ratio.

Outlet Pressure:	LP to 140 mbar	" WC to 2 psig
Max. Inlet Operating Pressure:	8.6 bar	125 psig
Connection Size(s):	Threaded 3/4", 1" and 1-1/4"	
Options:	Relief valve, Internal Monitor	

Compact and cost-effective regulator designed for mid-range commercial applications, well suited for quick on/off applications where shock problems occur.

Outlet Pressure:	LP to 140 mbar	" WC to 2 psig
Max. Inlet Operating Pressure:	8.6 bar	125 psig
Connection Size(s):	Threaded 1-1/2", 2", Flanged 2" and 3"	
Options:	Relief valve	

Versatile, large diaphragm controlled service regulator. Rugged construction enables the basic B34 model to cover applications through 350 mbar by merely changing adjustment springs.

Outlet Pressure:	LP to 340 mbar	" WC to 5 psig
Max. Inlet Operating Pressure:	8.6 bar	125 psig
Connection Size(s):	Threaded 1-1/4", 1-1/2", Flanged 2" and 3"	
Options:	Relief valve, Internal Monitor	

Service regulator with large orifices for high capacity or low inlet pressure, with massive relief capacity. The need for external relief valves for full capacity relief is eliminated in most applications.

Outlet Pressure:	LP to 340 mbar	" WC to 5 psig
Max. Inlet Operating Pressure:	8.6 bar	125 psig
Connection Size(s):	Threaded 1-1/2", 2", Flanged 2" and 3"	
Options:	Relief valve, Internal Monitor	

▶ Spring Loaded Regulators: Principle of Operation

Inlet pressure is reduced to a lower outlet pressure by restricting flow through an orifice to match a fluctuating downstream demand.

▶ As downstream demand increases, outlet pressure drops slightly, and the diaphragm moves downward. The valve seat moves farther away from the orifice face to allow flow to increase to match the increased demand.

▶ As downstream demand decreases, outlet pressure increases slightly, moving the diaphragm upward. The valve seat moves closer to the orifice face to restrict flow to match the decreased demand.

▶ When demand is shut off, outlet pressure continues to rise, moving the diaphragm up farther. The valve seat is driven into the orifice face, shutting off the flow of gas bubble-tight (lockup).

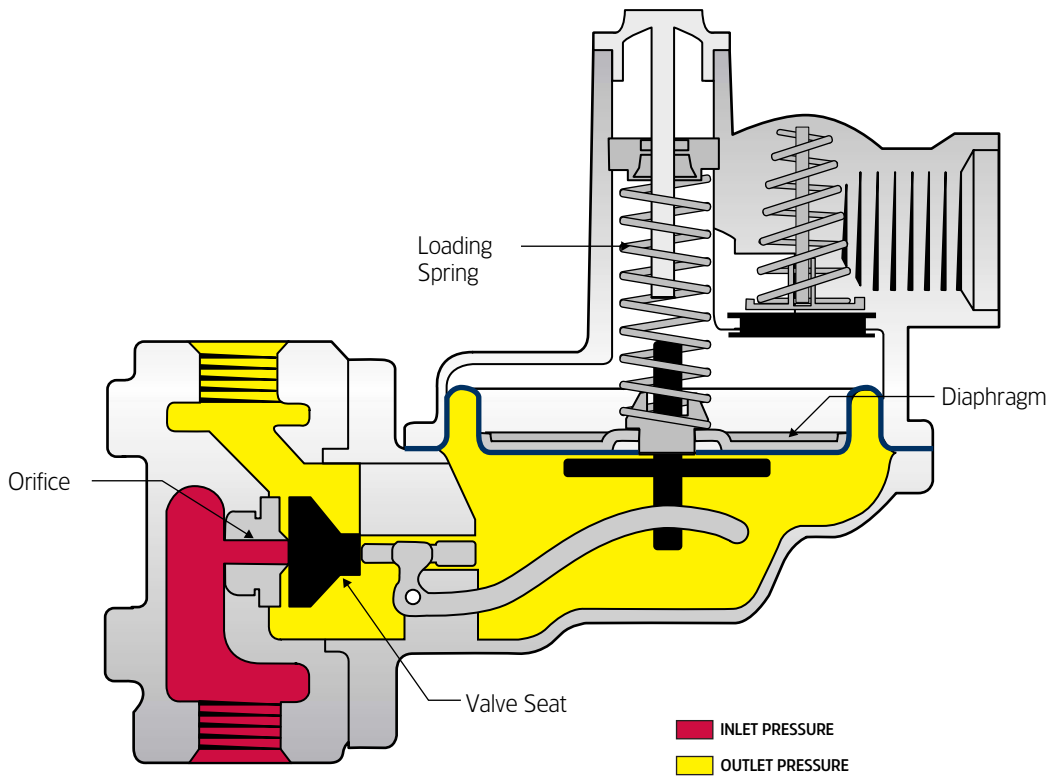

▶ Constant Loaded Regulators

These regulators use constant pressure supplied by a pilot regulator as the loading element for the main regulator. This design eliminates the outlet pressure droop at high flows associated with the spring effect in spring loaded regulators. CL regulators can thus maintain extremely accurate regulation at higher flows and higher outlet pressures than spring loaded regulators. Typical applications include elevated pressure gas system to commercial and industrial installations, fixed factor metering installations (eliminating the need for expensive instrumentation), and all types of applications requiring accurate “psi-to-psi” regulation at widely varying flow rates.

Features of Actaris constant loaded regulators include:

▶ Accurate Regulation

Constant loading pressure is supplied to the main regulator by a pilot regulator enabling “straight-line” regulation to be maintained over a wide range of flows and outlet pressures.

▶ Internal Bleed

Loading pressure bleeds downstream through the main diaphragm. No bleed occurs at lockup.

▶ Low Pressure Differential

CL regulators can operate with as little as 30 mbar differential between inlet and outlet pressure.

▶ CL31 Series

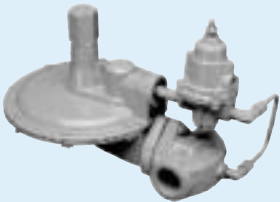

Provides extremely accurate regulation of intermediate volumes of gas at elevated pressure.

Only 1 pilot to cover the entire range of outlet pressure.

Outlet Pressure:	70 mbar to 1.4 bar	1 to 20 psig
Max. Inlet Operating Pressure:	8.6 bar	125 psig
Connection Size(s):	Threaded 3/4", 1" and 1-1/4"	
Options:	Relief-type pilot, Internal Monitor	

▶ CL231 Series



Compact and cost-effective regulator for accurate regulation at elevated pressures.

Only 1 pilot to cover the entire range of outlet pressure.

Outlet Pressure:	70 mbar to 1.4 bar	1 to 20 psig
Max. Inlet Operating Pressure:	8.6 bar	125 psig
Connection Size(s):	Threaded 1-1/4", 1-1/2", 2", Flanged 2" and 3"	
Options:	Relief-type pilot	

▶ CL34 Series



Provides extremely accurate regulation of gas over a wide range of flows and outlet pressures.

Typical applications include fixed factor billing on commercial and industrial installations.

Outlet Pressure:	70 mbar to 4 bar	1 to 60 psig
Max. Inlet Operating Pressure:	10 bar	150 psig
Connection Size(s):	Threaded 1-1/4", 1-1/2", 2", Flanged 2" and 3"	
Options:	Relief-type pilot, Internal Monitor	

▶ CL38 Series



Designed for high accuracy in high capacity applications. Typical applications include fixed factor billing on large commercial and industrial installations, and low pressure district regulator stations.

Outlet Pressure:	70 mbar to 2 bar	1 to 30 psig
Max. Inlet Operating Pressure:	10 bar	150 psig
Connection Size(s):	Threaded 1-1/2", 2", Flanged 2" and 3"	
Options:	Relief-type pilot, Internal Monitor	

▶ Constant Loaded Regulators: Principle of Operation

Inlet pressure is piped through external tubing to the pilot regulator. The pilot regulator is adjusted to reduce the inlet pressure to the desired outlet pressure plus enough pressure to overcome the light closing spring (loading pressure). Constant loading pressure is piped to the top of the main regulator diaphragm.

- ▶ When demand is approximately some hundred dm³/h or less, gas is supplied through a bleed hole in the main diaphragm.
- ▶ When demand increases above what can be supplied through the bleed hole, outlet pressure decreases slightly, causing an increase in pressure differential across the diaphragm. The diaphragm moves downward, and the main valve is repositioned to match the increased

downstream demand and recover desired outlet pressure.

- ▶ When flow decreases, outlet pressure increases slightly, causing a decrease in pressure differential across the diaphragm. The closing spring causes the diaphragm to move upward. The main valve is repositioned to restrict flow to match the decreased downstream demand and recover desired outlet pressure.
- ▶ When demand is shut off, outlet pressure continues to rise. The increased pressure is transmitted through the bleed hole to the pilot regulator. The pilot regulator locks up bubble-tight. The closing spring maintains bubble-tight lockup at the main valve.

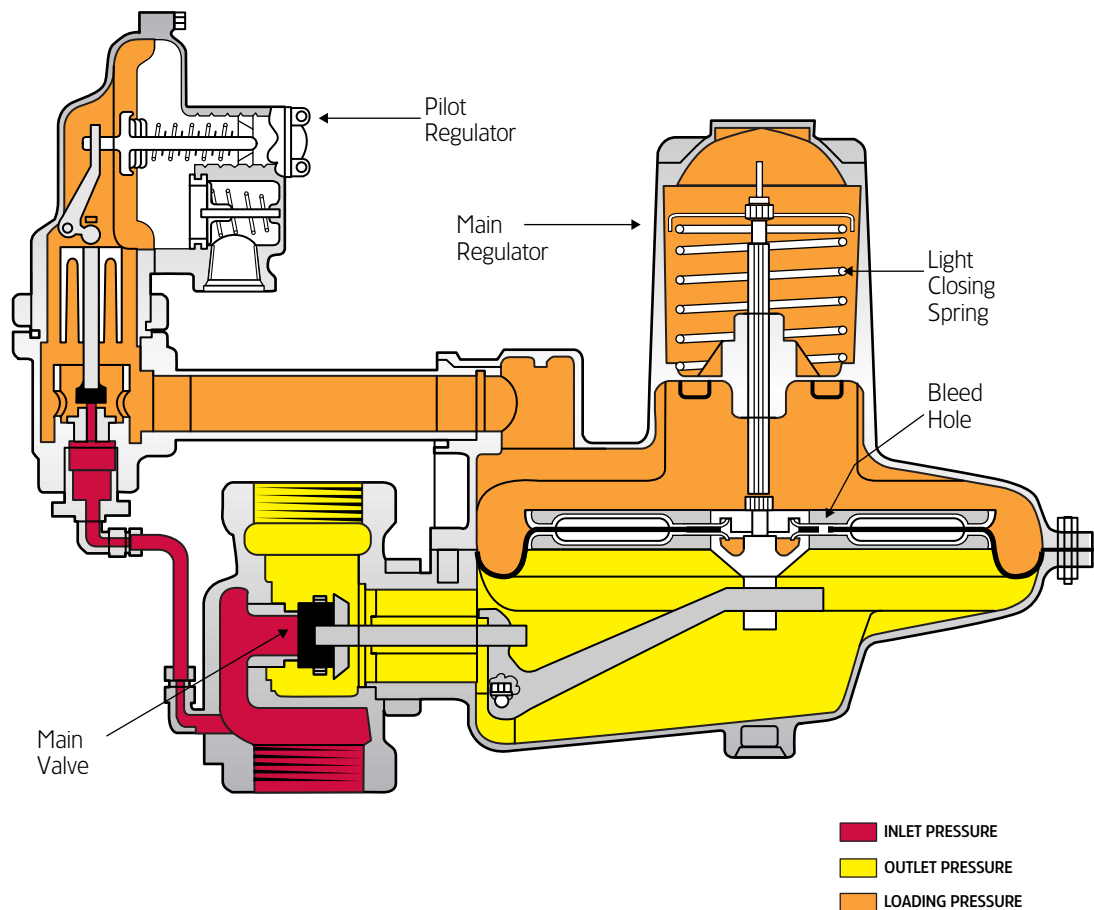

▶ Twin Parallel Flow Regulators

These regulators incorporate two diaphragm actuators and a single valve body into a self-contained regulator. Parallel regulation through dual orifices allows increased capacities. Twin relief valves (spring loaded models) provide double relief capacity. The use of two smaller orifices in place of one large orifice improves lockup, inlet effect performance, and relief performance.

The Internal Monitor versions of the twin regulators provide the highest level of safety available in a single regulating device. Twin sliding orifices provide normal dual regulation, with secondary monitor regulation and lockup in the event of multiple internal seat failures and/or a single diaphragm or lever failure.

▶ B531 Series



Designed for light to medium commercial applications where the added safety of twin sliding orifices and dual relief is desirable. Small diaphragm cases allow the B531 to respond quickly to fast on/off loads.

Outlet Pressure:	LP to 340 mbar	" WC to 2 psig
Max. Inlet Operating Pressure:	8.6 bar	125 psig
Connection Size(s):	Inlet: 3/4", 1" and 1-1/4" – Outlet: 3/4", 1-1/4", 1-1/2" and 2"	
Options:	Relief valve, Internal Monitor	

▶ B838 Series

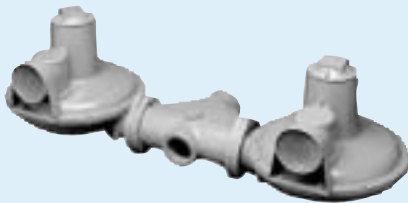

Provides increased capacity inherent in parallel flow regulators to handle large loads even at elevated pressure. It addresses fixed factor needs while retaining all of the favourable characteristics of spring loaded regulators, such as quick response, low lockup and internal relief.

Outlet Pressure:	LP to 340 mbar	" WC to 5 psig
Max. Inlet Operating Pressure:	8.6 bar	125 psig
Connection Size(s):	Threaded 2 x 2", Flanged 2 x 2", 2 x 3" and 2 x 4"	
Options:	Relief valve, Internal Monitor	

▶ CL838 Series

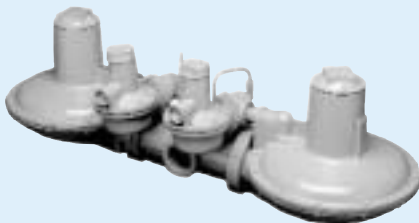

Provides extremely accurate regulation of gas in high capacity, elevated outlet pressure applications. Typical applications include district stations and high capacity fixed factor installations.

Outlet Pressure:	70 mbar to 2 bar	1 to 30 psig
Max. Inlet Operating Pressure:	10 bar	150 psig
Connection Size(s):	Threaded 2 x 2", Flanged 2 x 3" and 2 x 4"	
Options:	Relief-type pilot, Internal Monitor	

▶ Field Service Regulators

These regulators are designed to provide dependable first and second stage regulation for intermediate and high pressure applications. Typical applications include first stage regulation, farm & suburban taps, compressed air systems and medium to high pressure industrial applications.

▶ B35 Series



High pressure, first-cut regulator, ideal for use in multistage pressure reduction installations and monitor applications.

Outlet Pressure:	340 mbar to 10 bar	10 to 150 psig
Max. Inlet Operating Pressure:	69 bar	1.000 psig
Connection Size(s):	Threaded 3/4" and 1"	
Options:	Relief valve	

▶ VR 75 Series



Features integral resistance and versatile connection styles for pipeline tap applications.

Outlet Pressure:	0.5 to 16 bar	7 to 250 psig
Max. Inlet Operating Pressure:	100 bar	1.500 psig
Connection Size(s):	Flanged version up to 40 bar	600 psig
	Threaded 1", Flanged 1"	

▶ Regulators with built-in Slam-shut Valves

Actaris safety valves are designed to shut off under specific conditions such as excess pressure (OPSO), or, (optional) if there is a fall in downstream pressure (UPSO), due to downstream pipe rupture, for example. This increases the safety of the installation. The shut-off valve is completely independent of the regulator but both are integrated into the same body, making a self-contained, autonomous and extremely compact unit.

Features of Actaris regulators with built-in shut-off valves include:

▶ **Balanced valve** The balanced valve design allows the regulator to maintain a constant outlet pressure under any inlet pressure conditions and accommodates inlet pressures significantly higher than conventionally designed regulators. A single orifice size eliminates the need to select the orifice size according to operating conditions.

▶ **High capacity** The size of the clapet ensures a very high flow even with low upstream pressure.

▶ **Easy to use shut-off valve** The safety valve is easily regulated on site, independently of the setting of the regulator. An integrated bypass ensures that it is reset correctly.

▶ **Internal Creep relief** Most regulators can be fitted with a built-in creep relief valve that maintains downstream pressure under the relief set value by venting excess gas into the atmosphere. This ensures the safety shut-off valve is not triggered in the event of thermal expansion or during transient regimes of regulators.

▶ **Simple maintenance** The functional regulation parts and safety valves are accessible and can be dismantled easily and independently, making maintenance and repair particularly cost-effective.

▶ RB 1200



Designed for residential and light commercial applications. Its valve design makes it specially adequate for medium pressure service lines where it accommodates large inlet pressure variations while keeping very constant outlet. The RB 1200 offers angle or in-line connection styles providing flexibility for meter mounting or integration in compact meter boxes.

Outlet Pressure:	LP to 140 mbar	up to 2 psig
Max. Inlet Operating Pressure:	10 bar	150 psig
Connection Size(s):	Threaded 3/4"	
Options:	OPSO or OPSO/UPSO protection, creep relief valve	

▶ RB 2000 and 3200 Series



High-performance regulators with powerful lever ratio. The balanced-valve design provides constant outlet pressure under all inlet pressure conditions.

Outlet Pressure:	LP to 180 mbar	" WC to 2,6 psig
Max. Inlet Operating Pressure:	10 bar	150 psig
Connection Size(s):	Threaded 1" and 1-1/2"	
Options:	OPSO or OPSO/UPSO protection, creep relief valve	

Stand-alone slam-shut valve: **SSV 8200 and 8300 Series**

▶ RB 1700, 1700 H and 4000 Series



Compact regulator for high inlet pressure, such as first stage LPG pressure reduction. Extremely versatile series of direct-acting regulators with high flow rate turn-down and fast response, appropriate for commercial and industrial service, district stations and as well for burners and large appliance regulation.

Outlet Pressure:	LP to 5 bar	" WC to 70 psig
Max. Inlet Operating Pressure:	16 to 25 bar	250 to 360 psig
Connection Size(s):	Threaded 3/4", 1" and 1-1/2", Flanged DN 25, 40, 50, 50x80, 80 and 100	
Options:	OPSO or OPSO/UPSO protection	

Stand-alone slam-shut valve: **SSV 8500 and 8600 Series**

▶ RR 16 Series



Cartridge-type regulator with multiple orifice size(s) to match demanding flow requirements. The safety slam-shut valve 033 offers a very compact overpressure protection for inlet pressure up to 5 bar, while SL-IZ is adequate for higher inlet.

Outlet Pressure:	LP to 11 bar	" WC to 16 psig
Max. Inlet Operating Pressure:	16 bar	250 psig
Connection Size(s):	Flanged DN 25, 50 and 80	
Options:	Noise abatement, OPSO or OPSO/UPSO protection	

Stand-alone slam-shut valve: **SSV SL-IZ Series**

▶ Pilot Operated Regulators

Pilot operated regulators are equipped with a separate control system – or pilot – that provides the necessary energy for large size regulators or for those working in high pressure. These regulators are commonly used in all types of network stations, from city gate to

district stations.

They are also used in large metering stations which supply large industrial customers. With either integrated or separate safety valves, they allow for different arrangements of control and safety devices.

▶ RB 4700 Series



Pilot-operated regulators providing extremely accurate regulation over a wide range of flows and outlet pressures. The self-contained pilot system and the building block design eases the maintenance to an unprecedented extent. Typical applications include large industrial services, district stations and city gate stations.

Outlet Pressure:	LP to 13 bar	" WC to 190 psig
Max. Inlet Operating Pressure:	25 bar	360 psig
Connection Size(s):	Flanged DN 25, 40, 50, 80 and 100	
Options:	OPSO or OPSO/UPSO protection, noise abatement	
Stand-alone slam-shut valve:	SSV 8500 and 8600 Series	

▶ RB 4600 Series



A unique series of regulators featuring an active and a monitor RB 4700 pilot-operated regulator built together with a safety slam-shut valve on the same body. The result is a space-saving combination for very demanding gas pressure reducing installations.

Outlet Pressure:	LP to 13 bar	" WC to 190 psig
Max. Inlet Operating Pressure:	25 bar	360 psig
Connection Size(s):	Flanged DN 25, 40, 50, 80 and 100	
Options:	OPSO or OPSO/UPSO protection, noise abatement	
Stand-alone slam-shut valve:	SSV 8500 and 8600 Series	

▶ 12P Series



Designed for the high inlet pressure inter-regional piping systems for which its full safety concept and separated function blocks are particularly well-suited.

Outlet Pressure:	LP to 38 bar	" WC to 550 psig
Max. Inlet Operating Pressure:	40 bar	600 psig
Connection Size(s):	Flanged DN 25, 50, 80 and 100	
Options:	OPSO or OPSO/UPSO protection, noise abatement.	
Stand-alone slam-shut valve:	SSV SL-IZ Series, also available up to DN 200 and 100 bar pressure rating	

▶ Alphard P/AP



Pilot-operated regulators offering the most complete combination of features and safety options for high pressure city gate stations, such as fail-open or fail-close modes, integral monitor regulator, high efficiency built-in silencer, and integral shut-off valve.

Outlet Pressure:	LP to 60 bar	" WC to 870 psig
Max. Inlet Operating Pressure:	100 bar	1500 psig
Connection Size(s):	Flanged DN 25 to 300	
Options:	OPSO or OPSO/UPSO protection, noise abatement, monitor	
Stand-alone slam-shut valve:	SSV CA Series	

▶ Pilot Operated Regulators: Principle of Operation

Inlet pressure is piped through external tubing to the pilot system. First the inlet pressure is filtered through a fine filter and pressure is reduced to the outlet pressure plus enough pressure to overcome the regulator closing spring (feeding pressure).

This feeding pressure is then modulated by the pilot valve: the outlet pressure – sensed by the pilot sensing line – moves the pilot diaphragm which controls the pilot valve flow. Modulated pressure (motorization pressure) is piped to the regulator actuator where it opposes the closing spring and the outlet pressure, and bleeds downstream through a bleed hole.

▶ As downstream demand increases, outlet pressure drops slightly, and the pilot diaphragm moves to open further the pilot valve. The

motorization pressure increases and moves the regulator valve thus allowing flow to increase to match the increased demand.

▶ As downstream demand decreases, outlet pressure increases, moving the pilot diaphragm to reduce the pilot valve flow. The motorization pressure decreases and regulator closing spring causes the main valve to move closer to the seat. This restricts flow to match the decreased demand and recovers desired outlet pressure.

▶ When demand is shut off, the pilot valve locks up bubble-tight. The regulator closing spring maintains bubble-tight lockup at the main valve.

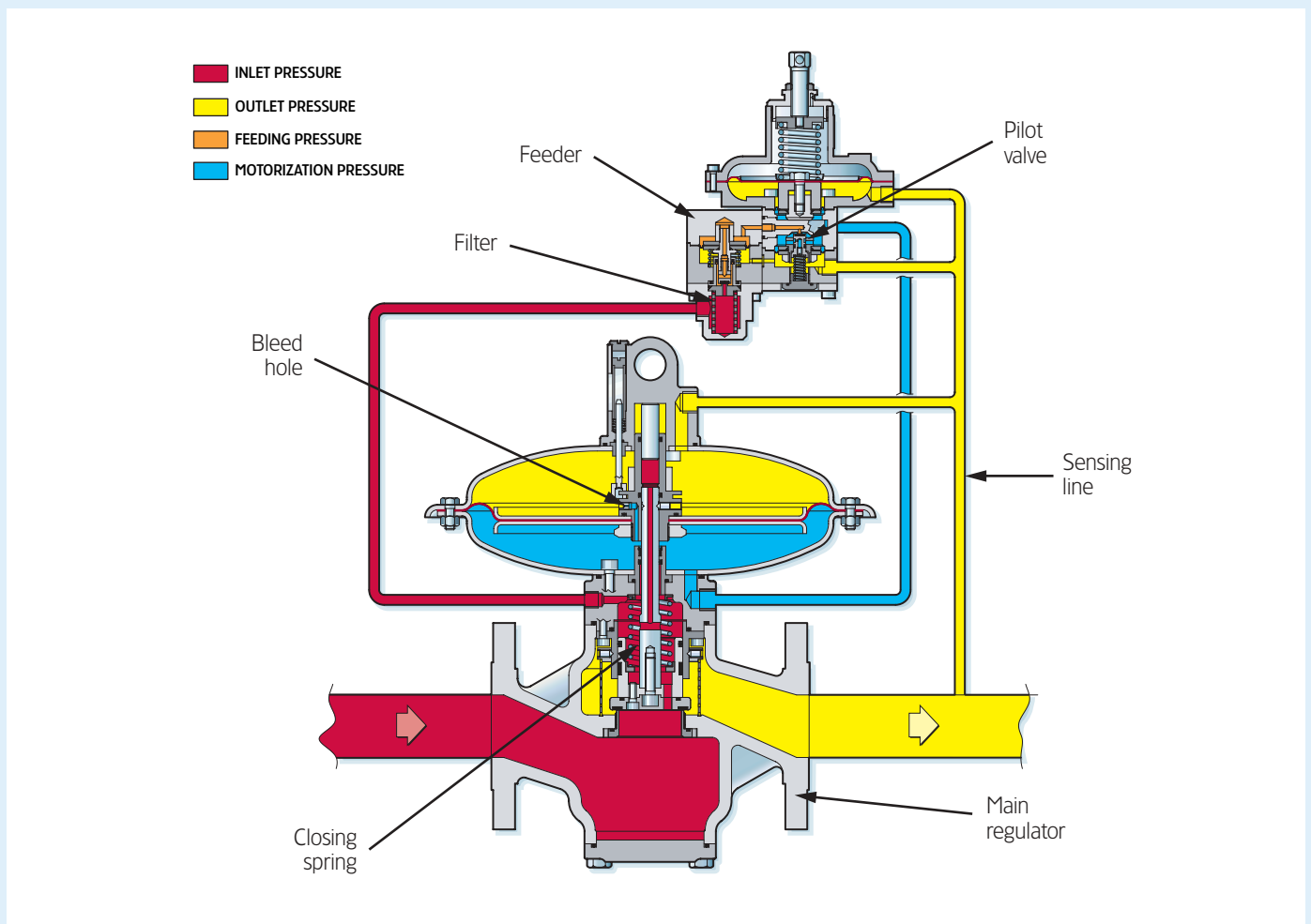

▶ Spring Loaded Regulators for the German Market

This range of regulators, from residential to light commercial applications, meets the most stringent requirements of the German codes of practices. All are approved by DIN-DVGW and meet DIN 33882/VP200 (PN 1 and PN 4 regulators) or the earlier DIN 3380 or 3381.

Unique safety features include:

▶ Gas loss protection

The gas supply is shut down if valve travel exceeds a set value (non adjustable) in the event of high flow and/or low inlet pressure. Reset can be automatic or manual.

▶ High flow cut-off

The gas supply is shut down if flow exceeds a set value (non adjustable) to protect downstream system against unauthorized intervention.

▶ Fire resistance

They have the ability to withstand high temperatures while only a very limited quantity of gas is released into the atmosphere. For regulators fitted with shut-off valve, a thermal fuse triggers the valve at a preset temperature.

PN1 regulators are fitted with a safety diaphragm, while a safety relief valve is optional for inlet pressures above 1 bar. The safety shut-off valve, a feature of PN 1 and PN 4 regulators, includes a thermal fuse to meet G495 requirements.

In addition, these regulators can be certified in our laboratory for energy billing systems to comply with Richtlinie G8.

▶ SER 10 Series



Designed for residential and light commercial applications. Its unique two-stage design provides exceptional safety and accuracy in medium pressure service lines. The SER 10 gives utilities all the feature required by the German DVGW code of practices. It offers also a large choice of connections to replac larger residential regulators.

Outlet Pressure:	up to 25 mbar	up to 10" WC
Max. Inlet Operating Pressure:	6 bar	90 psig
Connection Size(s):	Screwed 1-1/2", Flanged DN 25	
Options:	Creep relief valve, gas loss protection, safety shut-off valve with thermal fuse	

▶ 133 Series



High-performance regulators with multiple combinations of connection styles and safety arrangements, for residential and small commercial applications.

Outlet Pressure:	LP to 420 mbar	" WC to 6 psig
Max. Inlet Operating Pressure:	8.6 bar	125 psig
Connection Size(s):	Threaded 3/4", 1", Screwed 1-1/2", Flanged 1" Monopipe meter coupling 1"	
Options:	OPSO or OPSO/UPSO protection, creep relief valve, safety diaphragm, gas loss protection	

▶ 233 Series

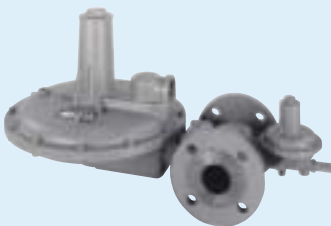

Versatile, large diaphragm-controlled regulators for large commercial applications.

Outlet Pressure:	LP to 700 mbar	" WC to 10 psig
Max. Inlet Operating Pressure:	8.6 bar	125 psig
Connection Size(s):	Threaded 1-1/2", Flanged DN 40 and 50	
Options:	OPSO or OPSO/UPSO protection, creep relief valve, safety diaphragm, fire resistance	

▶ Creep Relief Valves

Actaris creep relief valves maintain downstream pressure under set value by venting excess of gas to the atmosphere, avoiding triggering safety devices by thermal expansion or during transient regimes of regulators.

The SRV 285 relief valves are used downstream of pressure regulators to relieve limited volumes of gas where some pressure relieving tolerance

is acceptable, in industrial, district stations or city gate stations,

The SRV 275 relief valves are spring-loaded throttling relief valves. Colour coded springs in combination with a reinforced diaphragm provide good performance over their range of relief pressure.

▶ SRV 155



SRV 155 relief valves

Setting Range:	0.2 to 9.5 bar	3 to 140 psig
Connection Size(s):	Threaded 3/4 and 1"	

▶ SRV 275



SRV 275 relief valves

Setting Range:	LP to 0.5 bar	" WC to 70 psig
Connection Size(s):	Threaded 3/4 and 1"	

▶ SRV 285



SRV 285 relief valves

Setting Range:	2.5 to 16 bar	36 to 230 psig
Connection Size(s):	Threaded 3/4"	

▶ SRV 803



SRV 803 relief valves

Setting Range:	0.15 to 5 bar	1 to 70 psig
Connection Size(s):	Threaded 1"	

▶ SRV 801 and 811



SRV 801 and 811 relief valves

Setting Range:	LP to 700 mbar	" WC to 10 psig
Connection Size(s):	Threaded 1"	